

einfach sicher



Tel. 062 207 07 07
 Fax 062 207 07 00
 info@fensterbank.ch
 www.fensterbank.ch

Fensterbank

Kundenadresse _____

Sachbearbeiter/in _____

Telefon _____

Baustelle _____

Bestelldatum _____

Lieferdatum _____

gemäss Offerte

Fenster- und Brüstungsbänke

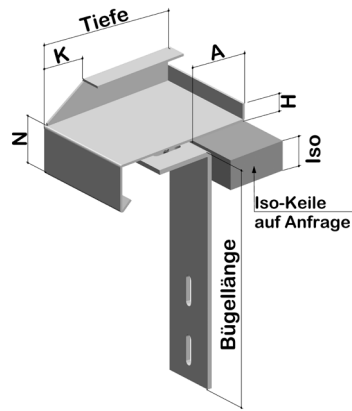

Lieferort

Baustelle	Kundenadresse	Wird abgeholt
-----------	---------------	---------------

Materialien und Oberflächen

Alu farbl. anod. 2 mm	Alu farbl. anod. 1.5 mm
Alu roh 2 mm	Alu roh 1.5 mm
Warzenbl. roh 3/5 mm	Duett roh 2/2.2 mm
CNS geschl. 1.25 mm	Duett gebeizt 2/2.2 mm
Reiskorn 2 mm	

Andere Oberfläche _____

Andere Materialien _____

Bordtypen

Pfeilerausschnitt mit Stehbord 2-seitig

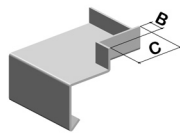

Pfeilerausschnitt mit Stehbord 3-seitig

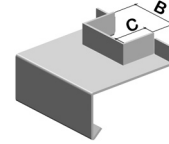

Pfeilerausschnitt mit Putzbord 2-seitig

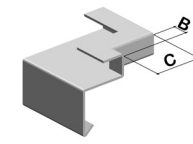

Pfeilerausschnitt mit Putzbord 3-seitig

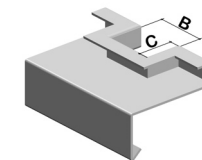

Stehbord St40-7/70

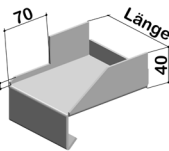

Putzbord P30/20

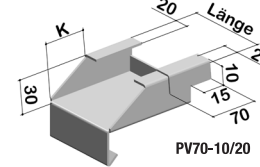

Spez. Klinkung Bord KH15/30

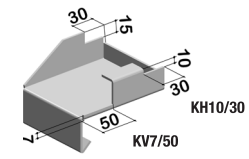

Pfeilerausschnitt in Gehrung

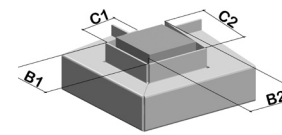

seitlicher Abbug

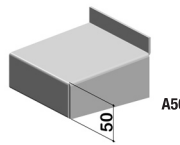

Gehrung mit Dilatation beliebige Winkel G90°, Formecke F90° oder F135°

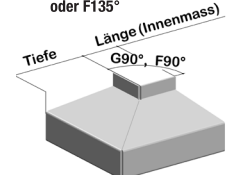

Wasserabweiser zu Steh- und Putzbord W7/50

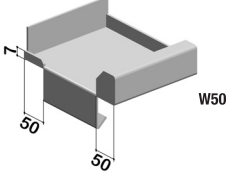

Spez. Klinkung Wetterschenkel KWS 40-25/8-15

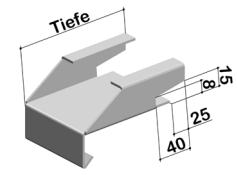

Normbügel

Langlöcher 6.5 x 26mm

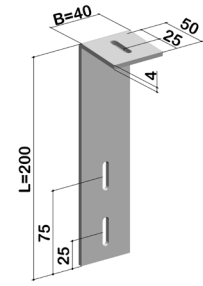

Position	Anzahl	Banklänge in mm	Tiefe in mm	Bordtyp von vorne		Tropfnahe N in mm	H in mm Löcher	Isolation	Abstand A in mm	Bügel Länge	Dollen	Klinkung K in mm	Zuschnitt
				links	rechts								

Skizzen